



# 5300 Series

Door furniture



The 5300 Series narrow stile furniture is designed for use in commercial applications, including exterior and interior doors for retail/shop front, educational, governmental, medical and public buildings. The narrow plate is ideal for use on narrow aluminium or timber stiles.

With a range of modern and contemporary lever designs, the 5300 Series will complement any décor. The handing mechanism of this Series allows the furniture to be handed on site, by simply rotation of the handle in the preferred direction of use prior to installing on the door.

## Features

- Constructed of commercial grade quality components including forged brass handles and extruded brass plates
- Heavy duty compression spring provides a smooth, positive return action of the lever and eliminates droop, extending the life of the product
- Symmetrically designed levers are able to be handed on site within seconds, with a simple 180° rotation of the lever in the preferred direction of use prior to installation
- Designed for use with Legge 995 narrow stile mortice locks, the 5300 Series can also be supplied to suit Legge 990MF mortice locks
- The 10 year warranty provides specifiers and users with assured quality and performance

## Specification guide

### Function

refer following pages

### Levers

refer following pages

### Finish

Chrome plate ..... CP  
 Polished brass ..... PB  
 Satin chrome plate ..... SCP

#### 1. Function

Select the desired function e.g. External plate with cylinder ..... 5300/

#### 2. Lever

Select the required lever design - e.g. Donatello #54 ..... 5300/54

#### 3. Finish

Select the desired finish e.g. Satin chrome plate ..... 5300/54SCP

**Note:** For furniture to suit 990MF locks add M to specification guide after function - applies to functions; External 00, 04, 10, 14, Internal 01, 03, 11, 13

## Handing guide

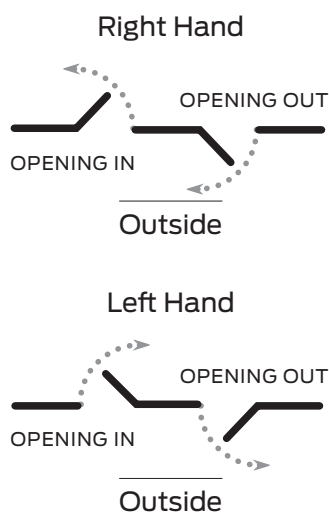

### Specifications

Door type	Timber or metal
Door thickness	32mm to 50mm
Spindle size	7.6mm
Compatible locks/ latches	Legge 995MF Series mortice locks Legge 990MF Series mortice locks for timber doors
Fixing centres	159mm
Fixing	Back to back, external plates concealed fixing, screws supplied with exterior plates only, screw length 75mm
Materials	Levers – forged & extruded brass Plate – extruded brass
Finishes	Chrome plate, polished brass and satin chrome plate
Warranty	10 year mechanical

## Lever handing

Handing is as simple as a turn of the handle.

The handing mechanism of the Legge 5300 Series eliminates the need to specify the handing of symmetrically designed levers. Handing of the lever is as simple as rotating the handle 180° as illustrated. This mechanism removes

the need to have stops and handing screws, thus saving time and money.

**Note:** For asymmetrically designed levers handing can not be reversed, and will require left or right handing to be specified when ordering.

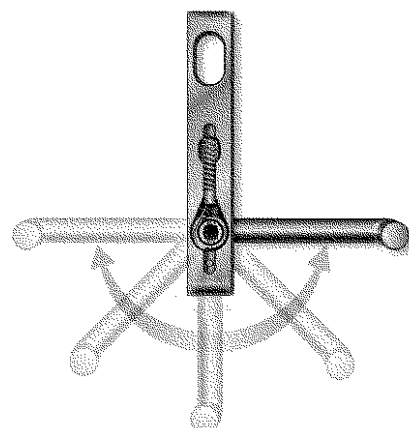

**For 995MF Series mortice lock**

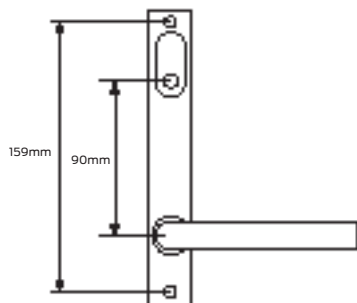

**For 990MF Series mortice lock**

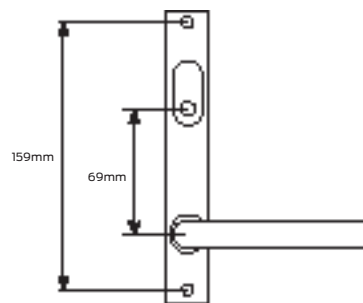

**External plates**

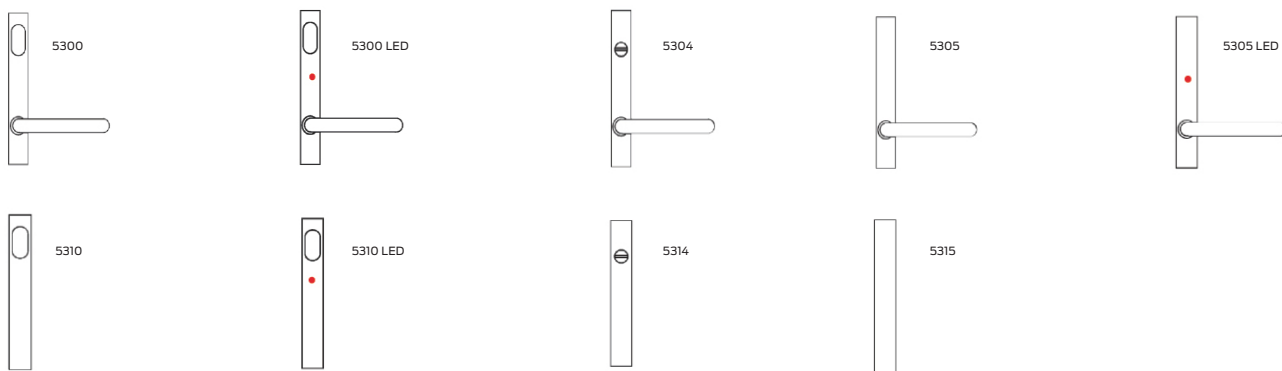



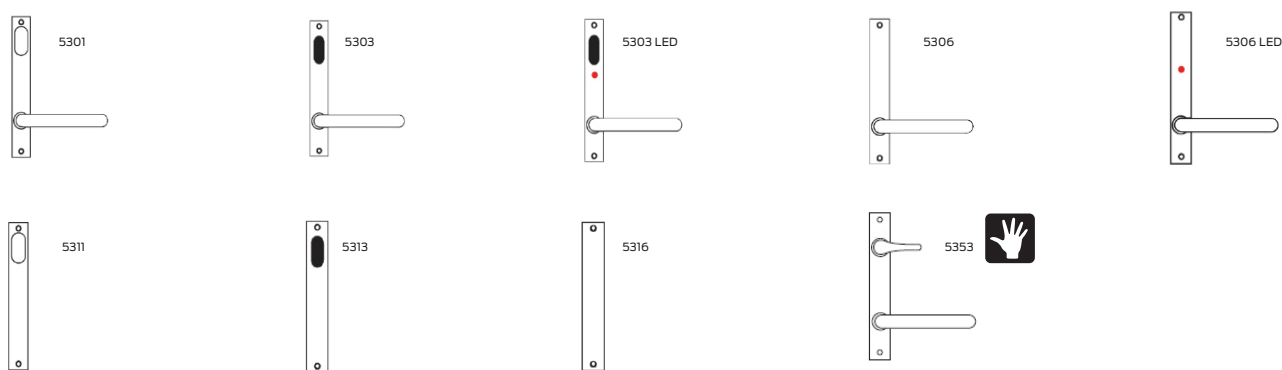



**Internal plates**



Depicted in RH

**Legend**

- Turn snib  LED 
- Cylinder hole  Large turn 
- Emergency button 
- Accessible Turn 



Denotes handed lever

# Legge 5300 Series levers

**Alessandro #55** 

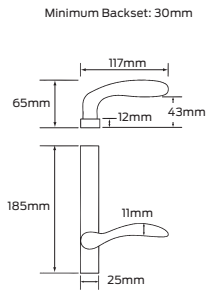

**Alpha #29**

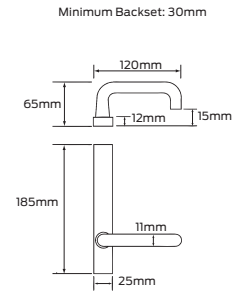

**Angelo #57**

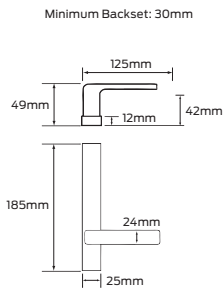

**Bergen**

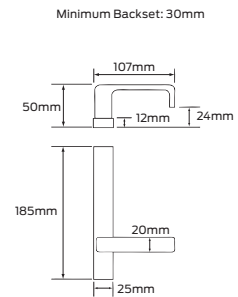

**Chagall #51** 

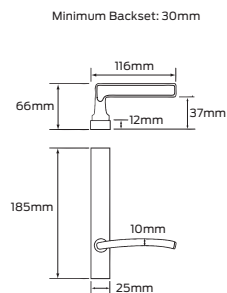

**Cisa #59**

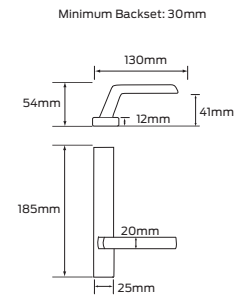

## Legge 5300 Series levers

**Diablo #15**

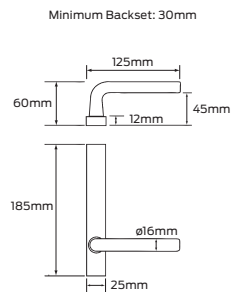

**Ergo #62**

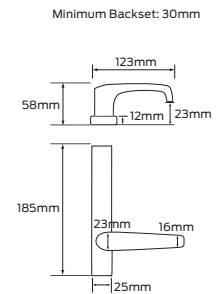

**Flaire**

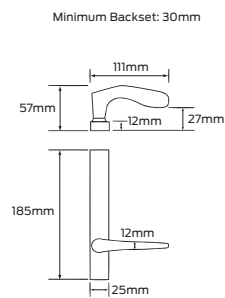

**Leonardo #12**

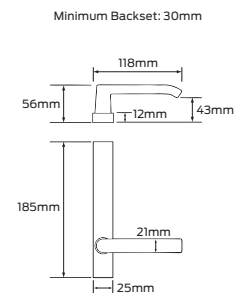

**Monet #50**

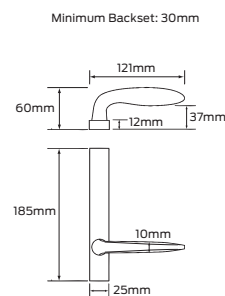

**Neptune**

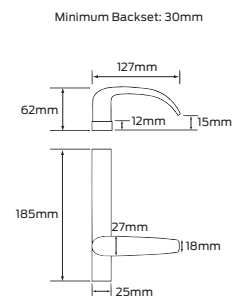

# Legge 5300 Series levers

**Renoir #52**

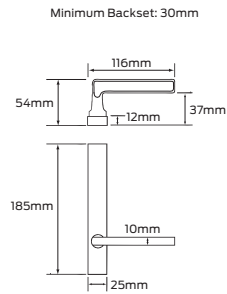

**Rubens #56**

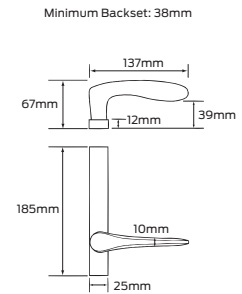

**Salvador #27**

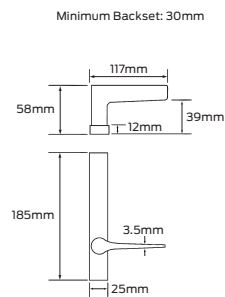

**Trilo #61**

